

4

3

2

1

B

B

A

A

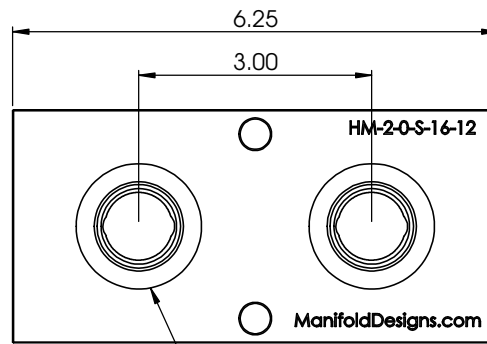
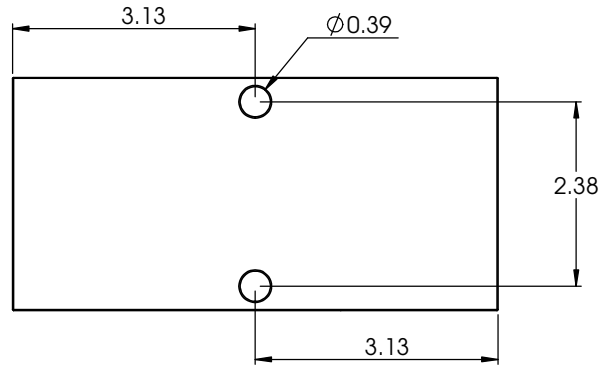
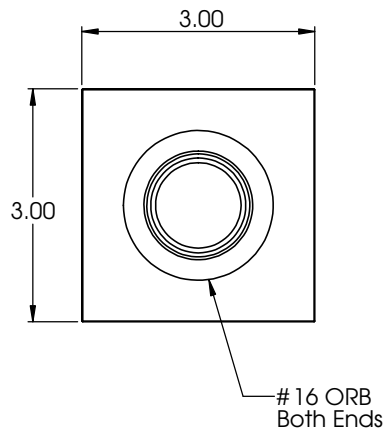

# 12 ORB Typ Face

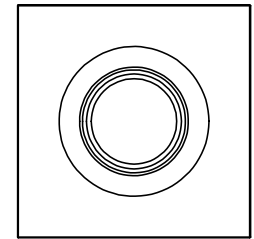

**PROPRIETARY AND CONFIDENTIAL**  
THE INFORMATION CONTAINED IN THIS DRAWING IS THE SOLE PROPERTY OF <INSERT COMPANY NAME HERE>. ANY REPRODUCTION IN PART OR AS A WHOLE WITHOUT THE WRITTEN PERMISSION OF <INSERT COMPANY NAME HERE> IS PROHIBITED.

		UNLESS OTHERWISE SPECIFIED:	NAME	DATE	TITLE: <b>Header Manifold</b>
		DIMENSIONS ARE IN INCHES	DRAWN		
		TOLERANCES:	CHECKED		
		FRACTIONAL: ±	ENG APPR.		
		ANGULAR: MACH ± BEND ±	MFG APPR.		
		TWO PLACE DECIMAL ±	Q.A.		SIZE DWG. NO. REV
		THREE PLACE DECIMAL ±	COMMENTS:		<b>B</b> HM-2-0-S-16-12
		INTERPRET GEOMETRIC TOLERANCING PER:			SCALE: 1:1 WEIGHT: SHEET 1 OF 1
		MATERIAL			
		6061			
		FINISH			
		Black Anodize			
NEXT ASSY	USED ON	APPLICATION			
		DO NOT SCALE DRAWING			

4

3

2

1